

Installation Instructions: Vox Kerradeco

Stack Panel Pty Ltd

Level 6, 10 Herb Elliott Avenue
Sydney Olympic Park NSW 2127
Australia

+61 2 9997 5196
info@stackpanel.com.au
stackpanel.com.au

Prior to construction, check with your local regulatory agency for local code requirements in your area.

As with any building project, installing Vox Kerradeco will have the best result when you think through the entire process in advance, familiarizing yourself with the materials and the application.

For additional installation support, call +61 2 9997 5196

Safety & Tools

Standard safe practices should, of course, be employed when using any tools during installation. Vox Kerradeco can be drilled, sawn, fastened or routed with normal woodworking tools.

Transport and Storage

- In a horizontal position, on a flat surface.
- In non-sunlight places.
- Storage or transporting temperature less than 60° C.

Temperature Resistance

- Do not use/store/transport in areas exposed to high temperatures above 60° C.

1. Information about product and installation

- KERRADECO boards may be installed on a wooden frame or using a glue.
- The boards can be installed horizontally or vertically, depending on the length (horizontally or vertically). Short panels (1,35 m) should be installed horizontally and vertically.
- The person installing the boards should have basic technical knowledge and be familiar with safety precautions.
- After unpacking, each board's quality should be checked (for scratches, pattern print errors, discolorations).
- Prior to the installation, the boards should be stored in the room where they are to be installed – to adjust to the ambient temperature.
- The boards should be assembled in the sequence specified by the numbers on their backsides.
- The boards may be finished with trim or without trim.
- The product can be installed in damp areas (kitchen, bathroom), providing it has been sealed with silicon
- It must not be installed in areas of increased temperatures (above 60° C), like a sauna, on a chimney, next to a cooker.
- The product is only suitable for indoor applications 100% recyclable.
- Any non-compliance with the instructions will void the product's warranty.

**STA
CK
PANEL**

Installation | 01

Installation Instructions: Vox Kerradeco

Stack Panel Pty Ltd

Level 6, 10 Herb Elliott Avenue
Sydney Olympic Park NSW 2127
Australia

+61 2 9997 5196
info@stackpanel.com.au
stackpanel.com.au

Essential Characteristics

| Parameter | Unit | Standard | Value |
|---|-----------------|----------------------------|--------------------------|
| Linear thermal shrinkage (at 75 °C, 1H) | % | EN479 | R≤3 |
| Mechanical strength | J | EN 13245-1 | not less than 20 (23.20) |
| Change of colour under accelerated artificial aging conditions at total radiation energy of 4.0 GJ/m ² | grayscale grade | EN ISO 4892-2 | not more than 4 |
| Water absorption | % | PN-EN ISO 62:2000 Method 1 | 1, 31 |
| Thermal conductivity | W/mK | | 0, 06 |

2. Installation of the boards

- The installation should always be done from the left to the right and from the bottom to the top.
- After placement of the first board, you need to verify its vertical / horizontal alignment and fasten it, then you slide on the next board and fasten it with a hammer and a tapping block.
- Before fastening the board permanently, you need to make sure that there is no gap between the boards and verify again its vertical / horizontal alignment.

Installation Instructions: Vox Kerradeco

Stack Panel Pty Ltd

Level 6, 10 Herb Elliott Avenue
Sydney Olympic Park NSW 2127
Australia

+61 2 9997 5196
info@stackpanel.com.au
stackpanel.com.au

3. Wooden frame construction

- The frame should be made of wooden battens fastened directly to the wall.
- Using a level, you must level the battens so they are flush with each other; if necessary, you can use shims or wedges to keep the boards level.
- The battens should run perpendicular to the direction of the boards – if the boards are being assembled vertically, the battens should be placed horizontally, and the other way around.
- Distance between the battens – 40 cm.
- The battens should be:
 - made of good quality wood, without any knots.
 - attached to the wall in a secure and strong manner, with screws or other mounting devices that are appropriate for the given surface.
 - the battens should be stored in the room in which they will be mounted for at least 24 hours (to adjust to the ambient temperature and humidity).

4. Installation on wooden frame

- Screw down the boards to the battens through the board's tongue, along the long edge and within the area marked by a groove.
- The screw should go in deep enough so that it does not snag when you slide on the next board.

5. Installation with glue

- The surface should be smooth, not crumbling, ensuring good adhesion.
- We recommend the use VOX mounting adhesive (art. No. 6004018) or any other universal adhesive based on hybrid polymer (silane-modified polyurethane) characterized by high initial bonding strength.
- The glue should be applied according to its instructions, in a well ventilated area.
- Apply the glue in a S-shaped motion.
- The surface of the first board on a given wall should be completely covered with glue; each successive one only along the edge with the tongue.

6. Cutting the boards

- To cut the boards you can use: hand saw, jigsaw, table saw.
- When adjusting the board for the trims, cut off the tongues or grooves with a sharp knife.



Installation Instructions: Vox Kerradeco

Stack Panel Pty Ltd

Level 6, 10 Herb Elliott Avenue
Sydney Olympic Park NSW 2127
Australia

+61 2 9997 5196
info@stackpanel.com.au
stackpanel.com.au

7. Hanging shelves on KERRADECO

- No additional weight should be applied to the board, and neither should it be a bearing element in construction.
- No hangers, shelves or any other objects may be directly screwed to the board.
- Instead, they should be mounted to the surface underneath the board, with screws or anchors intended for the given type of surface. To do so, drill the appropriate hole in the board, allowing for such possibility.

8. Cleaning

- Do not allow liquid stains to dry.
- From time to time, clean the boards with a damp cloth and a mild detergent.
- Intensive scrubbing and use of strong detergents may damage the board's surface or cause its discoloration.
- Do not clean with coarse and rough clothes, sponges or brushes.
- Never use solvents, acids or any other liquids based on these substances for cleaning.
- No cleaning liquids should be left on the surface, they must be rinsed off with water; cleaning substances left out on the surface may cause its discoloration.

Boards & Trims

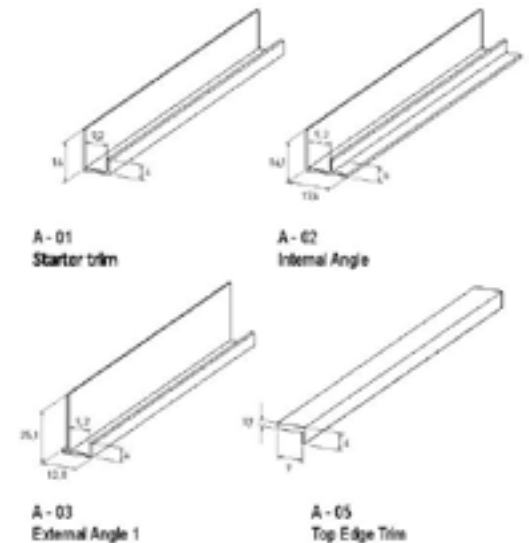
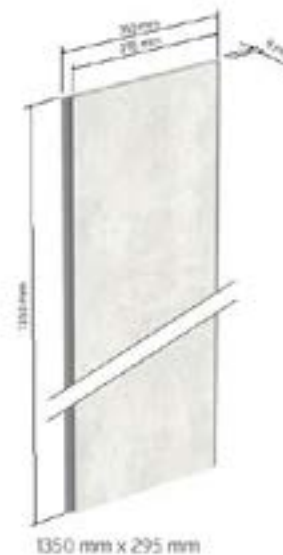

STA
CK
PANEL

Installation | 04

Installation Instructions: Vox Kerradeco

Stack Panel Pty Ltd

Level 6, 10 Herb Elliott Avenue
Sydney Olympic Park NSW 2127
Australia

+61 2 9997 5196
info@stackpanel.com.au
stackpanel.com.au

Tools

Basic Tools

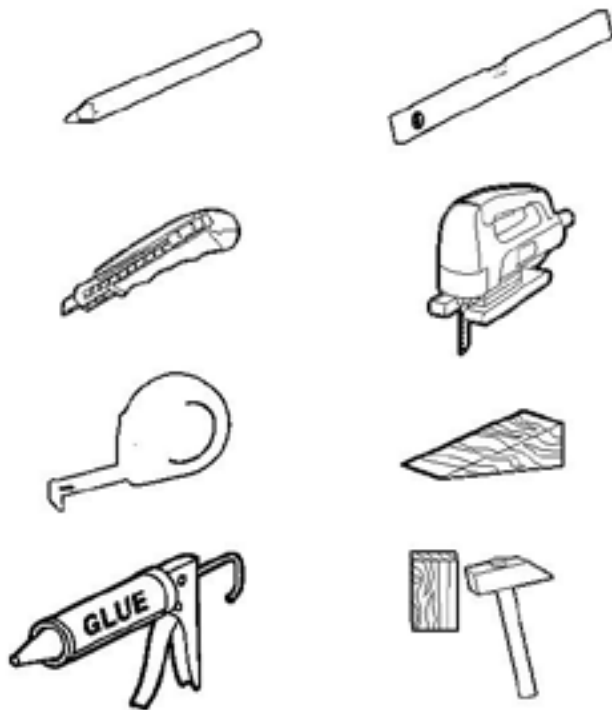

Additional Tools for Wooden Frame Construction

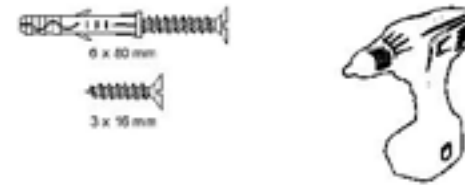

Additional Tools for Installation in Damp areas



Installation Instructions: Vox Kerradeco

Basic Rules for Boards Assembly & Their Sequence

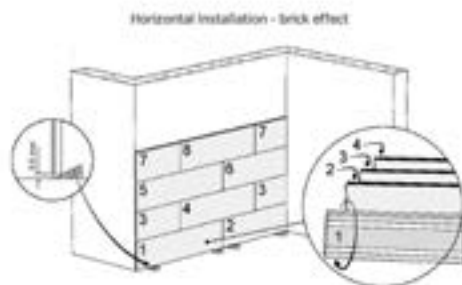
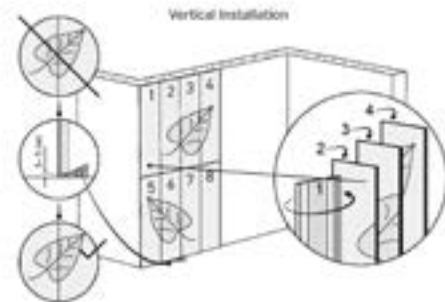
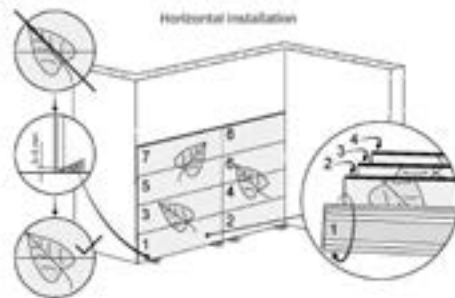

A wedge can be used to even the printed pattern and to maintain the distance on the finishing trim.

Installation on a Wooden Frame - Frame Construction

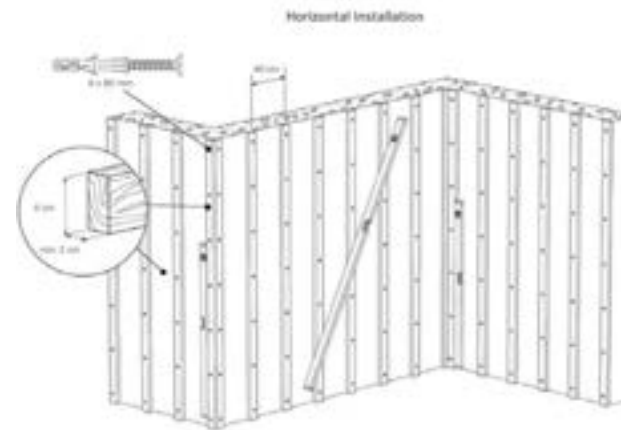
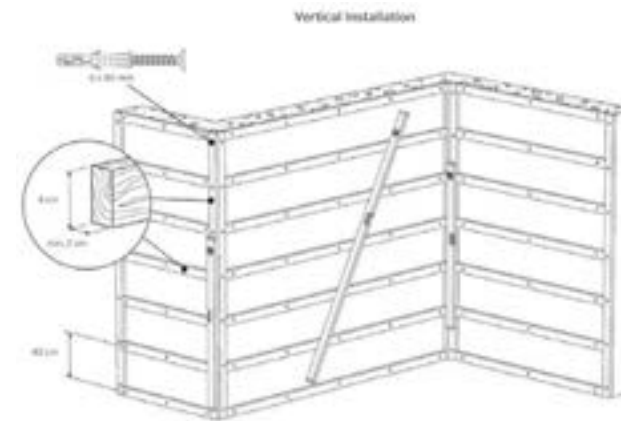

Installation Instructions: Vox Kerradeco

Stack Panel Pty Ltd

Level 6, 10 Herb Elliott Avenue
Sydney Olympic Park NSW 2127
Australia

+61 2 9997 5196
info@stackpanel.com.au
stackpanel.com.au

Installation on a Wooden Frame - Frame Construction

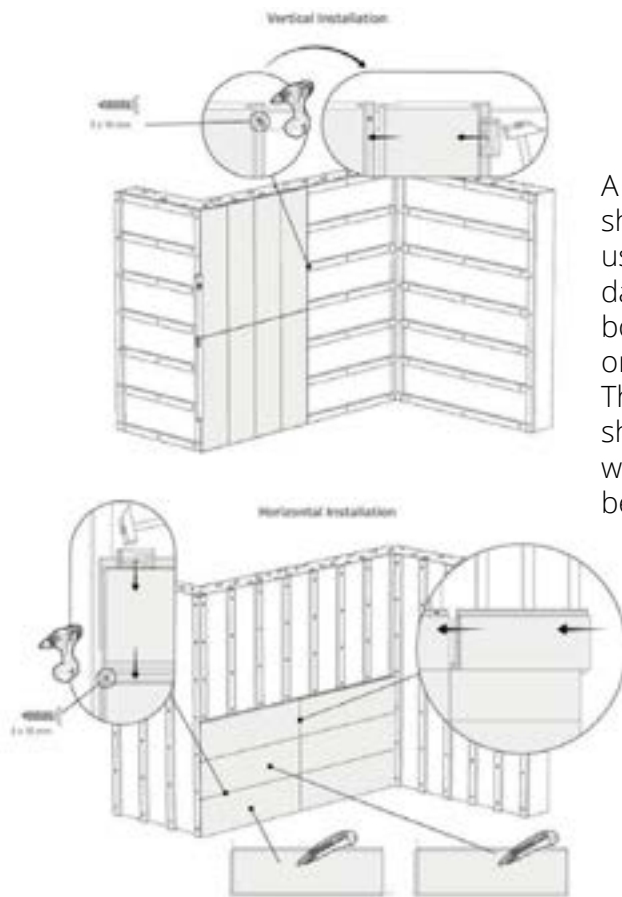

A tapping block should be used to avoid damage to the board's edge or its groove. The boards should be placed without any gaps between them.

Installation with Glue - Boards Assembly

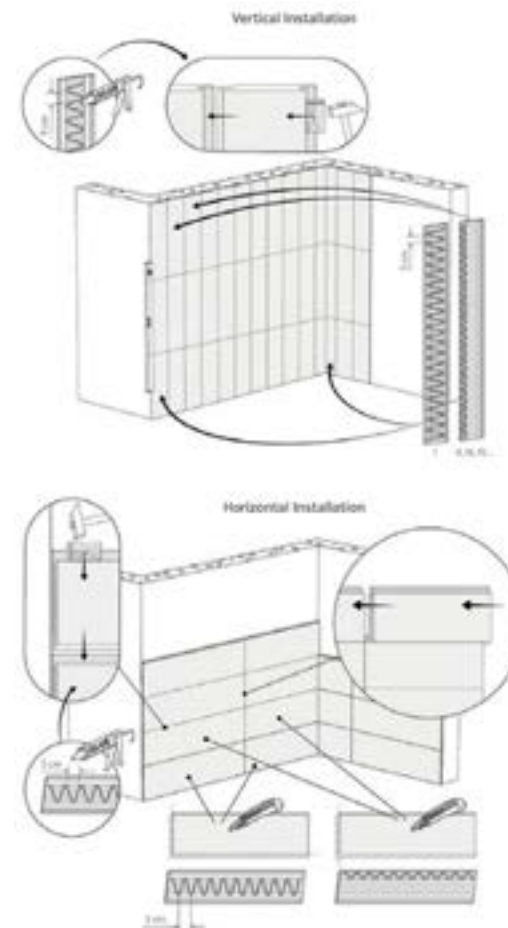

When installing boards with glue, make sure that the surface is smooth, not crumbling, ensuring good adhesion (for example: concrete, ceramic tiles, dry wall). The surface of the first board on a given wall should be completely covered with glue, each successive one only along the board's edge with the tongue.

STACK
PANEL

Installation | 07

Installation Instructions: Vox Kerradeco

Stack Panel Pty Ltd

Level 6, 10 Herb Elliott Avenue
Sydney Olympic Park NSW 2127
Australia

+61 2 9997 5196
info@stackpanel.com.au
stackpanel.com.au

Finishing Angles without the Finishing Trims

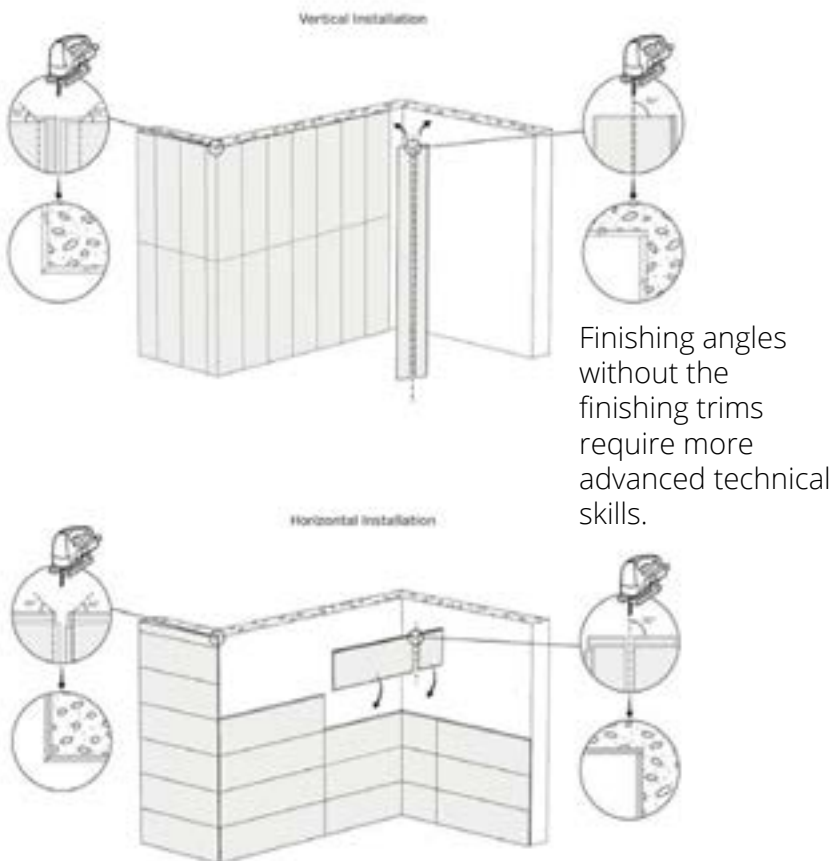

Finishing Angles with the Finishing Trims

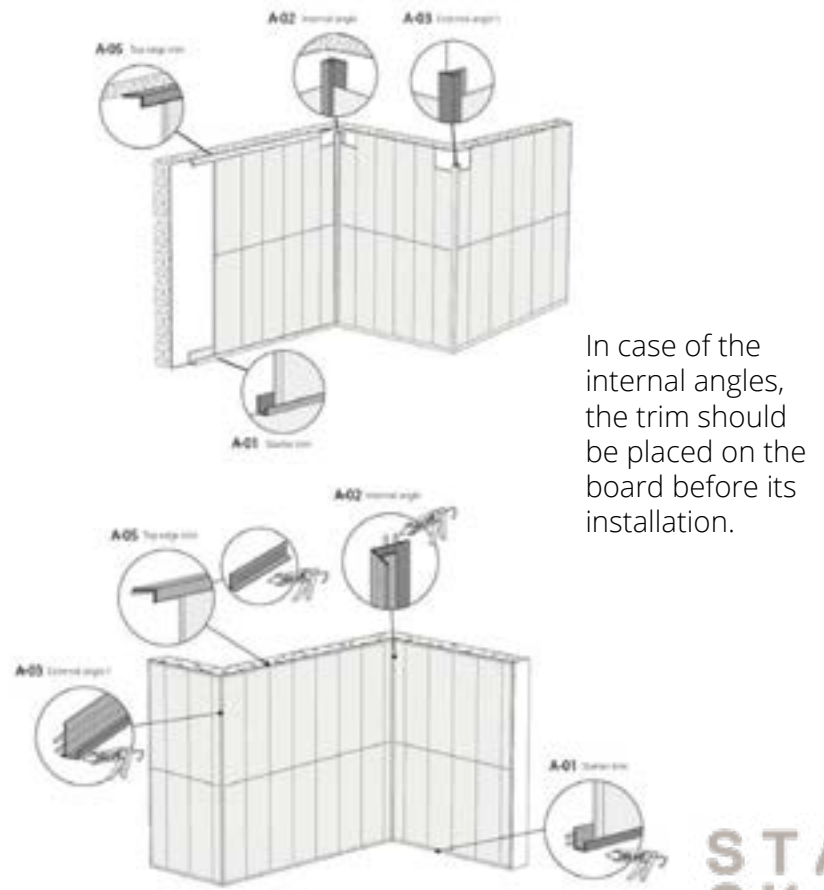

Installation Instructions: Vox Kerradeco

Stack Panel Pty Ltd

Level 6, 10 Herb Elliott Avenue
Sydney Olympic Park NSW 2127
Australia

+61 2 9997 5196
info@stackpanel.com.au
stackpanel.com.au

Installation in Damp Areas

(Not an ideal Installation)

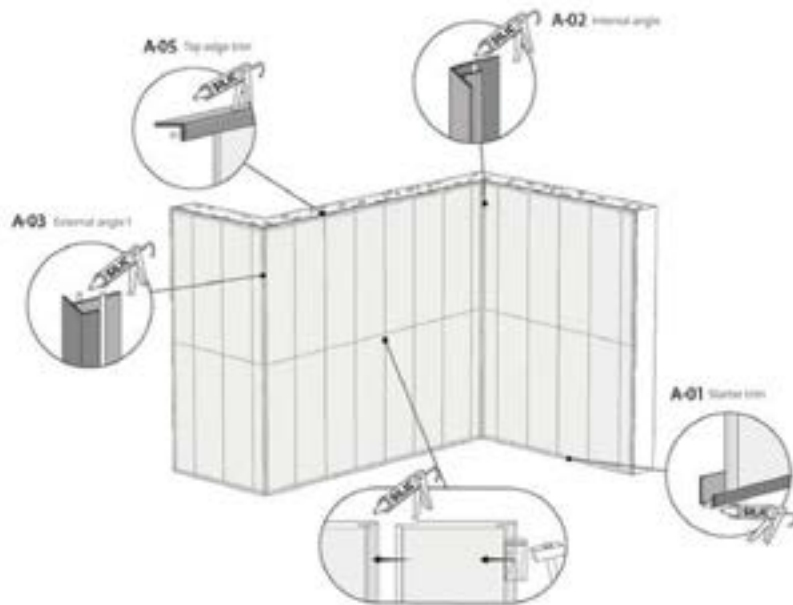

KERRADECO boards are water resistant, but their joints need to be additionally sealed with silicon – to prevent water from penetrating the gaps. Particular attention should be paid to the angles and to the spaces along the ceiling and the floor.

Note: The board will expand and contract at temperatures ± 20 °C from Install temperature.

Logistic Data

| panel 1350mm | qty in the box | net length | gross length | net width |
|-----------------------|-------------------|---------------------|-----------------|-----------------|
| panel | 1pc | 1350 mm | 1355 mm | 295 mm |
| box | 8pcs | | 1380 mm | |
| gross width | thick ness | covering surface | net weight | gross weight |
| 310 mm | 9mm | 0, 398 m2 | 2,18kg | 2,25kg |
| 322 mm | 90mm | 3, 186 m2 | 17, 41 kg | 18 kg |
| box weight | | | | |
| | | | 0,07kg | |
| | | | 0,59kg | |

**STA
CK
PANEL**

Installation | 09